

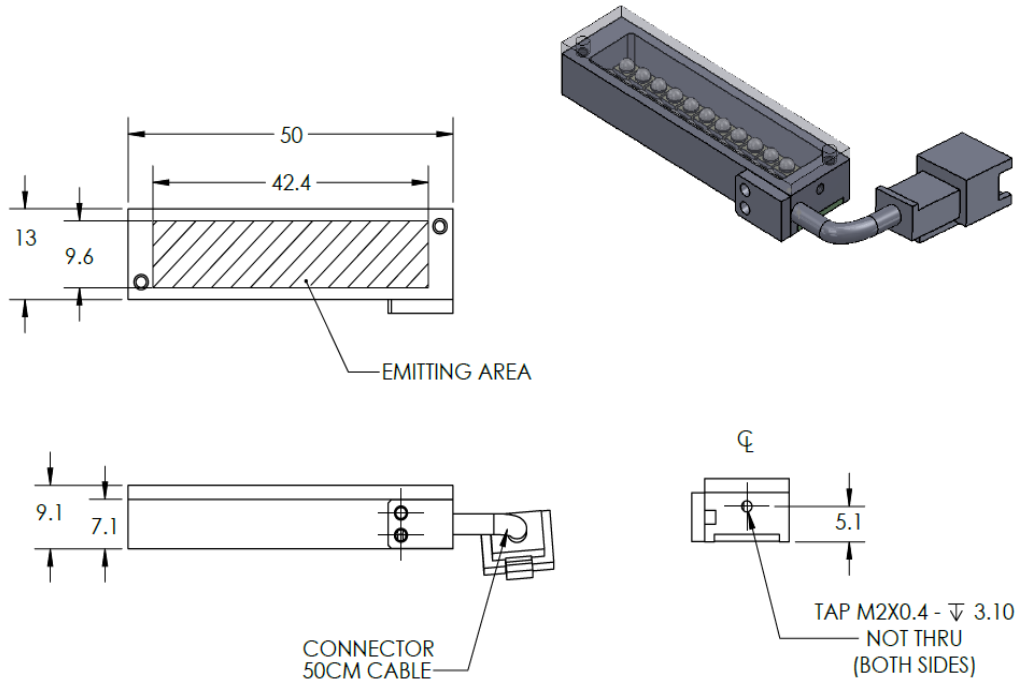

ILLUMINATOR DATA (ID)

LBM-00-040-2-R-24V

Lighting Dimension



Mechanical Information	
Casing Material	Aluminium
Storage Temperature Range	Temp 0-45°C, Humidity 20-85%
Weight	21 g
Length / Outer Diameter	50 mm
Width / Inner Diameter	13 mm
Thickness / Height	9.1 mm



ILLUMINATOR DATA-ID

LBM-00-040-2-R-24V

Optical Information				
Part Number		LBM-00-040-2-R-24V		
LED Color		RED		
Wavelength	(nm)	630		
Intensity (±15)	(Lux)	5430	4030	3130
Working Distance	(mm)	10	20	30
Illumination (number of row)		2		
Illumination Active Area				
Active Length / Outer Dia.	(mm)	42.4		
Active Width / Inner Dia.	(mm)	9.6		
Emission angle	(deg.)	0		
Eye Safety Class (IEC62471)		EXEMPT		
Electrical Information				
Lighting Supply Voltage (constant voltage mode)		24V ± 2%		
Continuous Current	(mA)	26		
Power Consumption	(W)	0.624		
Lighting casing temperature, Operating after 60 minutes	°C	39.3		
Strobe Mode Specification				
Pulse Operation		YES		
Max. Lighting Supply Voltage (Constant voltage power supply)	(V)	Pulsing at 24VDC to 48VDC, 0-10% Duty Cycle Recommended at 36VDC		
Pulse Current, (Max. 10msec) (Constant current power supply)	(mA)	78		
Max. Trigger Pulse Duration	(msec)	10		
Duty Cycle		0-10%		
Additional Information				
Additional Cooling Method		Attached to machine part for better heat dissipation		
Intensity Controller Selection		ANG, SD, ST & SDA series		
CE Conformity		YES		
RoHS Compliance		YES		
Connection				
Connector Type (Default):		JST SMR-03V		
Cable Length out from lighting :	(mm)	500		
Pin Configuration :		Pin	Signal	Cable Color
		1	LED +	RED
		2	N.C.	---
		3	LED -	WHITE
				
Application				
Illumination Type		Direct Illumination		
Application Use		General illumination, label inspection, character inspection, code recognition		



VISION CONSULTANCY
MAKING THE UNSEEN VISIBLE

Thank you for downloading this document from
www.machine-vision-shop.com

If you have any questions, you need help composing the
right package for your application or do you want to order?

Feel free to contact us via e-mail at sales@vision-consultancy.nl or visit our webshop.

Our vision experts are happy to help you.



Natascha Overhof



Christian Cromptvoets



VISION CONSULTANCY

Robert Schumandomein 2
6229 ES Maastricht
The Netherlands

+31 (0) 438 522 651

sales@vision-consultancy.nl
www.machine-vision-shop.com

Scan me to visit
[machine-vision-shop](http://machine-vision-shop.com)

