

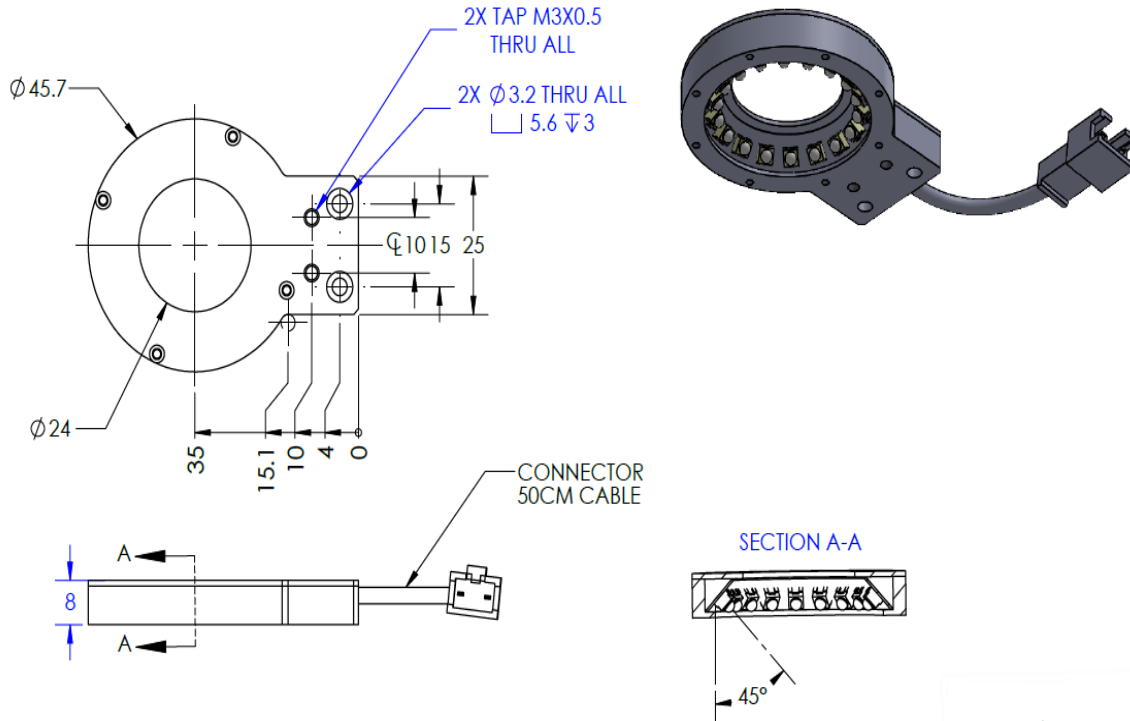

ILLUMINATOR DATA (ID)

LSQ-45-045-1-R-24V

Lighting Dimension



Mechanical Information	
Casing Material	Aluminium
Storage Temperature Range	Temp 0-45°C, Humidity 20-85%
Weight	30 g
Length / Outer Diameter	57.85 mm
Width / Inner Diameter	45.7 mm
Thickness / Height	8 mm



ILLUMINATOR DATA-ID

LSQ-45-045-1-R-24V

Optical Information			
Part Number		LSQ-45-045-1-R-24V	
LED Color		RED	
Wavelength	(nm)	630	
Intensity (±15)	(Lux)	54500	36900 23100
Working Distance	(mm)	7	13 23
Illumination (number of row)		1	
Illumination Active Area			
Active Area (diameter)	(mm)	36	
Emission angle	(deg.)	45	
Eye Safety Class (IEC62471)		EXEMPT	
Electrical Information			
Lighting Supply Voltage (constant voltage mode)		24V ± 2%	
Continuous Current	(mA)	30	
Power Consumption	(W)	0.72	
Lighting casing temperature, Operating after 60 minutes	°C	39.8	
Strobe Mode Specification			
Pulse Operation		YES	
Max. Lighting Supply Voltage (Constant voltage power supply)	(V)	Pulsing at 24VDC to 48VDC, 0-10% Duty Cycle Recommended at 36VDC	
Pulse Current, (Max. 10msec) (Constant current power supply)	(mA)	90	
Max. Trigger Pulse Duration	(msec)	10	
Duty Cycle		0-10%	
Additional Information			
Additional Cooling Method		Attached to machine part for better heat dissipation	
Intensity Controller Selection		ANG, SD, ST & SDA series	
CE Conformity		YES	
RoHS Compliance		YES	
Connection			
Connector Type (Default):		JST SMR-03V	
Cable Length out from lighting :	(mm)	500	
Pin Configuration :		Pin	Signal
		1	LED +
		2	N.C.
		3	LED -
			Cable Color
			RED

			WHITE
			
Application			
Illumination Type		Direct Illumination	
Application Use		Substrate inspection, label inspection, flat surface, fiducially recognition	



VISION CONSULTANCY
MAKING THE UNSEEN VISIBLE

Thank you for downloading this document from
www.machine-vision-shop.com

If you have any questions, you need help composing the
right package for your application or do you want to order?

Feel free to contact us via e-mail at sales@vision-consultancy.nl or visit our webshop.

Our vision experts are happy to help you.



Natascha Overhof



Christian Cromptvoets



VISION CONSULTANCY

Robert Schumandomein 2
6229 ES Maastricht
The Netherlands

+31 (0) 438 522 651

sales@vision-consultancy.nl
www.machine-vision-shop.com

Scan me to visit
[machine-vision-shop](http://machine-vision-shop.com)

