

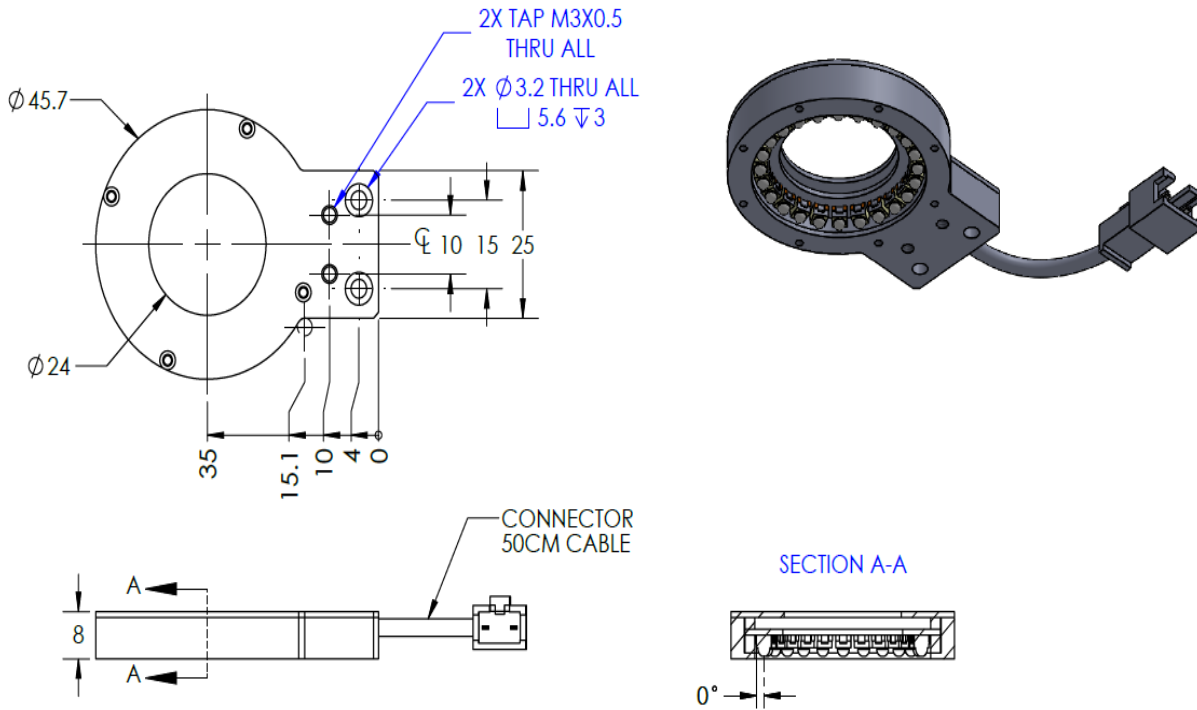

ILLUMINATOR DATA (ID)

LSQ-00-045-1-W-24V

Lighting Dimension



Mechanical Information	
Casing Material	Aluminium
Storage Temperature Range	Temp 0-45°C, Humidity 20-85%
Weight	32 g
Length / Outer Diameter	57.85 mm
Width / Inner Diameter	45.7 mm
Thickness / Height	8 mm



ILLUMINATOR DATA-ID

LSQ-00-045-1-W-24V

Optical Information		LSQ-00-045-1-W-24V																								
Part Number		LSQ-00-045-1-W-24V																								
LED Color		WHITE																								
Wavelength	(nm)	*Refer to the Chromaticity Table below																								
Intensity (±15)	(Lux)	12900	11700	10900																						
Working Distance	(mm)	55	60	65																						
Illumination (number of row)		1																								
Illumination Active Area																										
Active Area (diameter)	(mm)	36																								
Emission angle	(deg.)	0																								
Eye Safety Class (IEC62471)		EXEMPT																								
*CHROMATICITY TABLE		<table border="1"> <tr> <td>X</td> <td>0.296</td> <td>0.287</td> <td>0.307</td> <td>0.311</td> <td>X</td> <td>0.311</td> <td>0.307</td> <td>0.33</td> <td>0.33</td> </tr> <tr> <td>Y</td> <td>0.276</td> <td>0.295</td> <td>0.315</td> <td>0.294</td> <td>Y</td> <td>0.294</td> <td>0.315</td> <td>0.339</td> <td>0.318</td> </tr> </table>					X	0.296	0.287	0.307	0.311	X	0.311	0.307	0.33	0.33	Y	0.276	0.295	0.315	0.294	Y	0.294	0.315	0.339	0.318
X	0.296	0.287	0.307	0.311	X	0.311	0.307	0.33	0.33																	
Y	0.276	0.295	0.315	0.294	Y	0.294	0.315	0.339	0.318																	
Electrical Information																										
Lighting Supply Voltage (constant voltage mode)		24V ± 2%																								
Continuous Current	(mA)	60																								
Power Consumption	(W)	1.44																								
Lighting casing temperature, Operating after 60 minutes	°C	42.1																								
Strobe Mode Specification																										
Pulse Operation		YES																								
Max. Lighting Supply Voltage (Constant voltage power supply)	(V)	Pulsing at 24VDC to 48VDC, 0-10% Duty Cycle Recommended at 36VDC																								
Pulse Current, (Max. 10msec) (Constant current power supply)	(mA)	180																								
Max. Trigger Pulse Duration	(msec)	10																								
Duty Cycle		0-10%																								
Additional Information																										
Additional Cooling Method		Attached to machine part for better heat dissipation																								
Intensity Controller Selection		ANG, SD, ST & SDA series																								
CE Conformity		YES																								
RoHS Compliance		YES																								
Connection																										
Connector Type (Default):		JST SMR-03V																								
Cable Length out from lighting :	(mm)	500																								
Pin Configuration :		Pin	Signal	Cable Color																						
		1	LED +	RED																						
		2	N.C.	---																						
		3	LED -	WHITE																						
																										
Application																										
Illumination Type		Direct Illumination																								
Application Use		Substrate inspection, label inspection, flat surface, fiducially recognition																								



VISION CONSULTANCY
MAKING THE UNSEEN VISIBLE

Thank you for downloading this document from
www.machine-vision-shop.com

If you have any questions, you need help composing the
right package for your application or do you want to order?

Feel free to contact us via e-mail at sales@vision-consultancy.nl or visit our webshop.

Our vision experts are happy to help you.



Natascha Overhof



Christian Cromptvoets



VISION CONSULTANCY

Robert Schumandomein 2
6229 ES Maastricht
The Netherlands

+31 (0) 438 522 651

sales@vision-consultancy.nl
www.machine-vision-shop.com

Scan me to visit
[machine-vision-shop](http://machine-vision-shop.com)

