

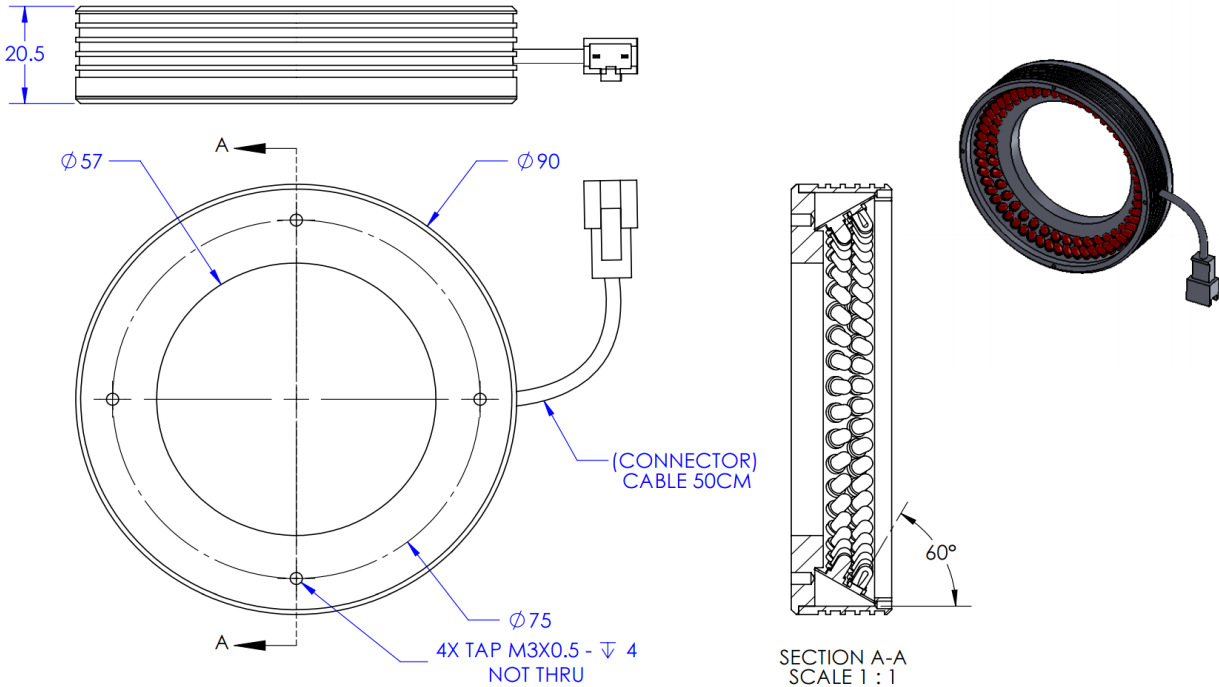

ILLUMINATOR DATA-ID

LLA-60-090-2-B-24V

Lighting Dimension



Mechanical Information	
Casing Material	Aluminium
Storage Temperature Range	Temp 0 - 45°C, Humidity 20-85%
Weight	114 g
Length / Outer Diameter	90 mm
Width / Inner Diameter	57 mm
Thickness / Height	20.5 mm



ILLUMINATOR DATA-ID

LLA-60-090-2-B-24V

Optical Information		LLA-60-090-2-B-24V		
Part Number		LLA-60-090-2-B-24V		
LED Color		BLUE		
Wavelength	(nm)	470		
Intensity (±15%)	(Lux)	168200	185700	170700
Working Distance	(mm)	15	20	25
Illumination (number of row)		2		
Illumination Active Area				
Active Length / Outer Diameter	(mm)	83		
Active Width / Inner Diameter	(mm)	57		
Emission angle	(deg.)	60		
Eye Safety Class (IEC62471)		II		
Electrical Information				
Lighting Supply Voltage (constant voltage mode)		24V ± 2%		
Continuous Current	(mA)	240		
Power Consumption	(W)	5.76		
Lighting casing temperature, Operating after 60 minutes	°C	57.7		
Strobe Mode Specification				
Pulse Operation		YES		
Max. Lighting Supply Voltage (Constant voltage power supply)	(V)	Pulsing at 24VDC to 48VDC, 0-10% Duty Cycle, Recommended at 36VDC		
Pulse Current, (Max. 10msec) (Constant current power supply)	(mA)	720		
Max. Trigger Pulse Duration	(msec)	10		
Duty Cycle		0-10%		
Additional Information				
Additional Cooling Method		Attached to machine part for better heat dissipation		
Intensity Controller Selection		ANG, ST, SD and SDA Series		
CE Conformity		YES		
RoHS Compliance		YES		
Connection				
Connector Type (Default):		JST SMR-03V		
Cable Length out from lighting :	(mm)	500		
Pin Configuration :		Pin	Signal	Cable Color
		1	LED +	RED
		2	N.C.	---
		3	LED -	WHITE
				
Application				
Illumination Type		Direct Illumination		
Applicattion Use		Edge detection, scratched on metal or glossy surface.		



VISION CONSULTANCY
MAKING THE UNSEEN VISIBLE

Thank you for downloading this document from
www.machine-vision-shop.com

If you have any questions, you need help composing the
right package for your application or do you want to order?

Feel free to contact us via e-mail at sales@vision-consultancy.nl or visit our webshop.

Our vision experts are happy to help you.



Natascha Overhof



Christian Cromptvoets



VISION CONSULTANCY

Robert Schumandomein 2
6229 ES Maastricht
The Netherlands

+31 (0) 438 522 651

sales@vision-consultancy.nl
www.machine-vision-shop.com

Scan me to visit
[machine-vision-shop](http://machine-vision-shop.com)

